

Low Noise Silicon Bipolar RF Transistor

- For broadband amplifiers up to 2 GHz and fast non-saturated switches at collector currents from 0.5 mA to 20 mA
- Pb-free (RoHS compliant) package
- Qualification report according to AEC-Q101 available

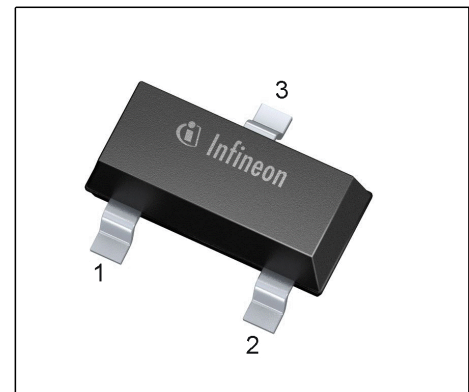

ESD (Electrostatic discharge) sensitive device, observe handling precaution!

Type	Marking	Pin Configuration			Package
BFR92P	GFs	1=B	2=E	3=C	SOT23

Maximum Ratings at $T_A = 25\text{ °C}$, unless otherwise specified

Parameter	Symbol	Value	Unit
Collector-emitter voltage	V_{CEO}	15	V
Collector-emitter voltage	V_{CES}	20	
Collector-base voltage	V_{CBO}	20	
Emitter-base voltage	V_{EBO}	2.5	
Collector current	I_C	45	mA
Base current	I_B	4	
Total power dissipation ¹⁾ $T_S \leq 93\text{ °C}$	P_{tot}	280	mW
Junction temperature	T_J	150	°C
Storage temperature	T_{Stg}	-55 ... 150	

Thermal Resistance

Parameter	Symbol	Value	Unit
Junction - soldering point ²⁾	R_{thJS}	205	K/W

¹⁾ T_S is measured on the collector lead at the soldering point to the pcb

²⁾ For the definition of R_{thJS} please refer to Application Note AN077 (Thermal Resistance Calculation)

Electrical Characteristics at $T_A = 25\text{ °C}$, unless otherwise specified

Parameter	Symbol	Values			Unit
		min.	typ.	max.	
DC Characteristics					
Collector-emitter breakdown voltage $I_C = 1\text{ mA}, I_B = 0$	$V_{(BR)CEO}$	15	-	-	V
Collector-emitter cutoff current $V_{CE} = 20\text{ V}, V_{BE} = 0$	I_{CES}	-	-	10	μA
Collector-base cutoff current $V_{CB} = 10\text{ V}, I_E = 0$	I_{CBO}	-	-	100	nA
Emitter-base cutoff current $V_{EB} = 2.5\text{ V}, I_C = 0$	I_{EBO}	-	-	100	μA
DC current gain $I_C = 15\text{ mA}, V_{CE} = 8\text{ V}$, pulse measured	h_{FE}	70	100	140	-

Electrical Characteristics at $T_A = 25\text{ }^\circ\text{C}$, unless otherwise specified

Parameter	Symbol	Values			Unit
		min.	typ.	max.	
AC Characteristics (verified by random sampling)					
Transition frequency $I_C = 15\text{ mA}$, $V_{CE} = 8\text{ V}$, $f = 500\text{ MHz}$	f_T	3.5	5	-	GHz
Collector-base capacitance $V_{CB} = 10\text{ V}$, $f = 1\text{ MHz}$, $V_{BE} = 0$, emitter grounded	C_{cb}	-	0.39	0.55	pF
Collector emitter capacitance $V_{CE} = 10\text{ V}$, $f = 1\text{ MHz}$, $V_{BE} = 0$, base grounded	C_{ce}	-	0.23	-	
Emitter-base capacitance $V_{EB} = 0.5\text{ V}$, $f = 1\text{ MHz}$, $V_{CB} = 0$, collector grounded	C_{eb}	-	0.64	-	
Minimum noise figure $I_C = 2\text{ mA}$, $V_{CE} = 6\text{ V}$, $Z_S = Z_{Sopt}$, $f = 900\text{ MHz}$ $I_C = 2\text{ mA}$, $V_{CE} = 6\text{ V}$, $Z_S = Z_{Sopt}$, $f = 1.8\text{ GHz}$	NF_{min}	-	1.4	-	dB
Power gain, maximum available ¹⁾ $I_C = 15\text{ mA}$, $V_{CE} = 8\text{ V}$, $Z_S = Z_{Sopt}$, $Z_L = Z_{Lopt}$, $f = 900\text{ MHz}$ $I_C = 15\text{ mA}$, $V_{CE} = 8\text{ V}$, $Z_S = Z_{Sopt}$, $Z_L = Z_{Lopt}$, $f = 1.8\text{ GHz}$	G_{ma}	-	16	-	
Transducer gain $I_C = 15\text{ mA}$, $V_{CE} = 8\text{ V}$, $Z_S = Z_L = 50\text{ }\Omega$, $f = 900\text{ MHz}$ $I_C = 15\text{ mA}$, $V_{CE} = 8\text{ V}$, $Z_S = Z_L = 50\text{ }\Omega$, $f = 1.8\text{ MHz}$	$ S_{21e} ^2$	-	13	-	dB

$$^1G_{ma} = |S_{21e} / S_{12e}| (k - (k^2 - 1)^{1/2})$$

Total power dissipation $P_{\text{tot}} = f(T_S)$

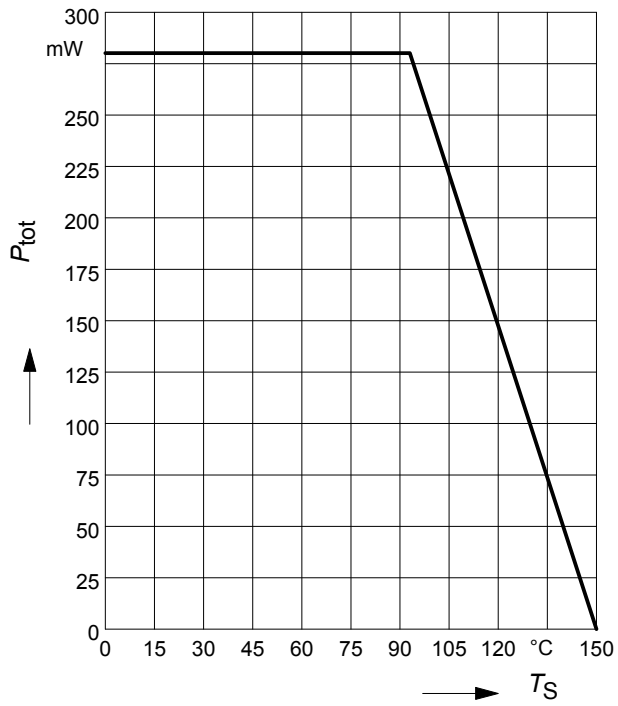

Package Outline

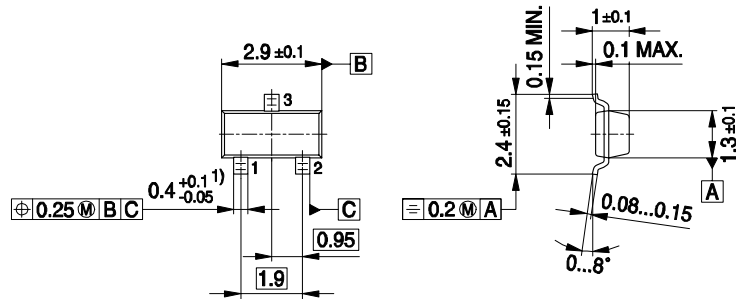
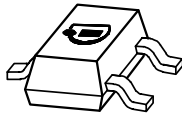

1) Lead width can be 0.6 max. in dambar area

SOT23-PO V08

Foot Print

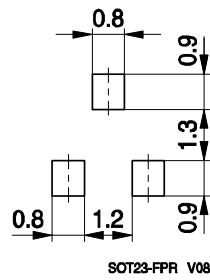

SOT23-FPR V08

Marking Layout

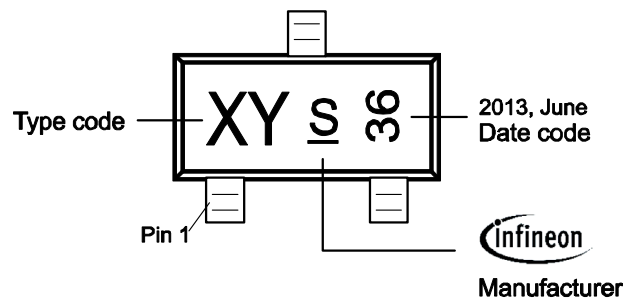

Standard Packing

Reel o 180 mm: 3.000 Pieces / Reel
 Reel o 330 mm = 10.000 Pieces / Reel

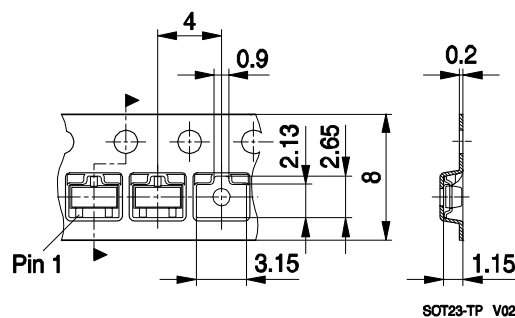

SOT23-TP V02